

Value and Versatility in Engineered Wood Shelters, Buildings and Bridges

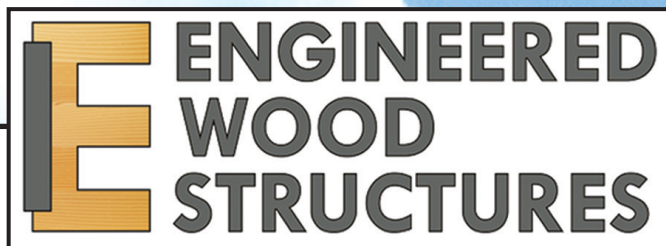

1455 Lincoln Avenue
Holland, MI 49423

www.ewsstructures.com
(616) 796-1260

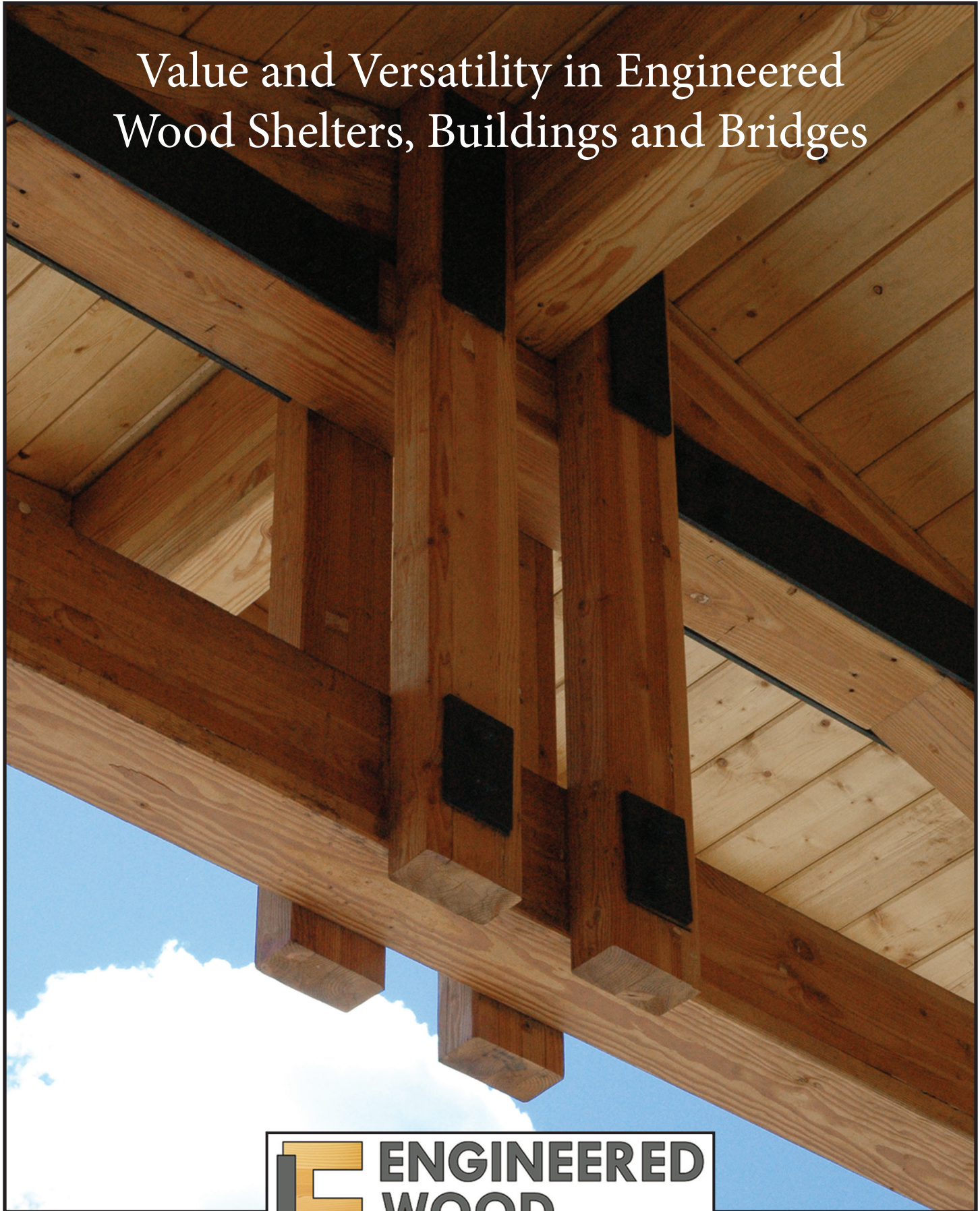
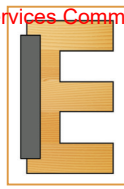

Value and Versatility in Wood Shelters, Enclosed Structures and Bridges



Wood shelters, enclosed structures and bridges by Engineered Wood Structures Inc. utilize a number of different engineered wood components.

Glue-laminated Southern Yellow Pine (SYP) members are the most widely used materials, but structures can also contain treated and non-treated dimensional timbers and lumber, and Glue-laminated Alaskan Yellow Cedar, Western Red Cedar and Douglas Fir components. For all shelters, tubular steel or steel I-beam columns are available as an option. Columns can be surface mounted or direct bury.

Glue-laminated wood components conform to the standard specification for structural glue-laminated timbers, AITC-117 found in the American Institute of Timber Construction Standards. The laminated lumber is Southern Yellow Pine graded to meet design values and requirements ANSI/AITC A-190.1. The appearance specification for all glu-laminated wood components is architectural.

Roof Decking is #1 kiln-dried Southern Yellow Pine 2x6 tongue and groove with a “v” groove on the finished face of the board. Fascia is 2x8 D and better S4S kiln-dried Western Red Cedar. Optional roofing materials, such as standing seam, metal panels, pre-cut metal panels, asphalt shingles and sawn cedar shingles are available at an added cost.

EWS offers a large variety of standard shelters, enclosed structures and pedestrian bridges, but has the engineering and design staff to accommodate any kind of custom structure. EWS also has the engineering and design staff to accommodate any kind of custom structure. Decades of experience go into the design, engineering and fabrication of your Engineered Wood Structure.

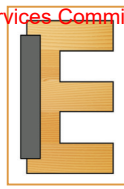

Contents



PAGE FOUR
Low Pitch Laminated Curved
Beam Shelters



PAGE NINE
Band Shells and Amphitheater
Structuress



PAGE SIX
Solid and Open Arch Shelters



PAGE TEN
Restroom, Concessions and
Park Activity Buildings



PAGE SEVEN
Timber Truss Shelters



PAGE ELEVEN
Gazebos



PAGE EIGHT
Post and Beam Shelters



PAGE ELEVEN
Pedestrian Bridges



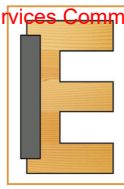

Low-Pitch Laminated Curved Beam Shelters



WLP20X20TA-P3-WB

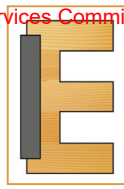

Low-Pitch Laminated Curved Beam Shelters

One piece laminated wood beams span from column-to-column. Columns can be treated Southern Yellow Pine (SYP), Alaskan Yellow Cedar or tube steel.

Bay spacings are maximum of 8'-0" O.C., but may be adjusted for custom sizes and/or roof load requirements. The standard roof pitch is 3/12. Alternate pitches are also available as an option. Overhang offsets are 24" all around the perimeter.

EWS has many standard sizes, but custom sizes are also available upon request. Special pricing may apply.

Standard Sizes -



WLP16X20	WLP20X20	WLP24X24	WLP30X36	WLP36X36	WLP40X44	WLP50X52
WLP16X24	WLP20X28	WLP24X28	WLP30X44	WLP36X44	WLP40X52	WLP50X60
WLP16X28	WLP20X36	WLP24X36	WLP30C52	WLP36X52	WLP40X60	WLP50X68
WLP16X36	WLP20X44	WLP24X44	WLP30X60	WLP36X60	WLP40X68	WLP50X76
WLP16X44	WLP20X52	WLP24X52	WLP30X68	WLP36X68	WLP40X76	WLP50X84

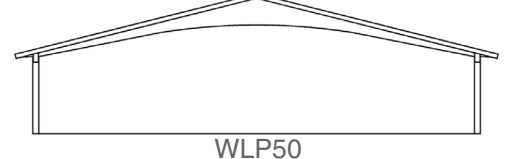
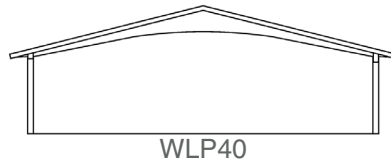

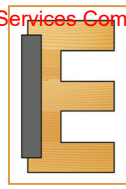

Solid and Open Arch Shelters

Two-piece laminated wood solid arches, and three-piece laminated wood open arches span from column-to-compression ring on the polygonal shelters, and column-to-ridge in rectangular shelters. These Gothic-style arches are used in hexagons, octagons, squares and rectangular shelters.

- Gables: 12' - 70'
- Squares: 12' - 50'
- Hexagons: 12' - 70'
- Octagons: 12' - 70'

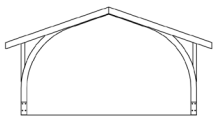

OPEN ARCH GABLES

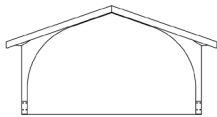

SOLID ARCH GABLES

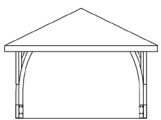

OPEN ARCH SQUARES

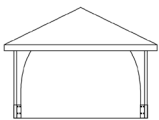

SOLID ARCH SQUARES

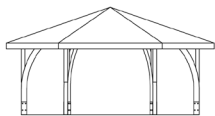

OPEN ARCH HEXAGONS

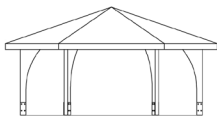

SOLID ARCH HEXAGONS

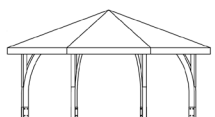

OPEN ARCH OCTAGONS

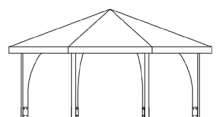

SOLID ARCH OCTAGONS

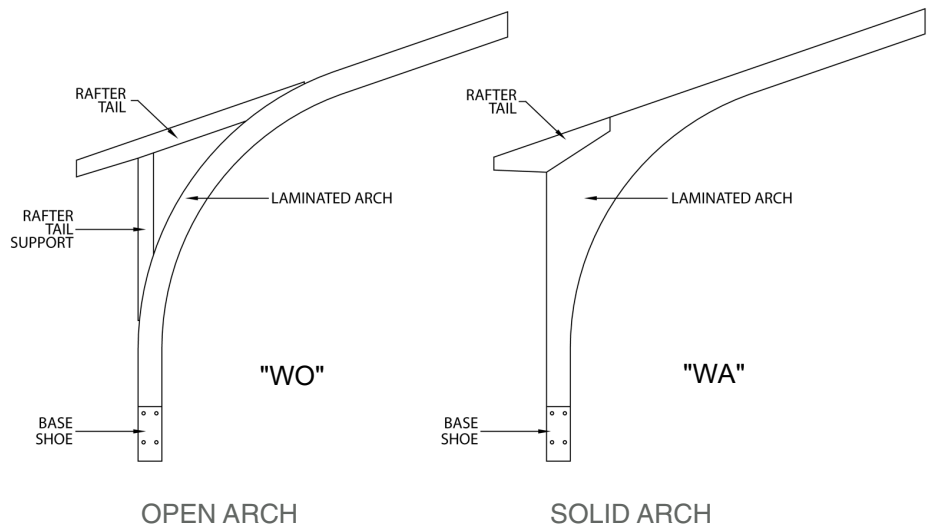

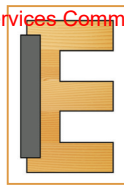

Timber Truss Shelters



Open Timber Truss gabled shelters have heavy laminated beam trusses that are engineered and fabricated at the factory. The glue-laminated wood is typically architectural SYP. Roof decking is #1 SYP 2x6 T&G. The steel connection plates are e-coated and powder coated for maximum corrosion resistance. All fasteners are galvanized.

The dual-pitch version (WPD) has a 4/12 pitch on one side and a 6/12 pitch on the opposite side. The standard Timber Truss Shelter (WTG) has a 4/12 pitch.

Custom sizes and roof pitches are available. Gable closures and ceiling packages are also available at an added cost.

Both the standard and dual pitch shelters are available in the following sizes:

16X20	16X28	20X28
20X36	24X28	24X36
24X44	28X36	28X44
28X52	34X44	34X52
34X60	34X76	44X60

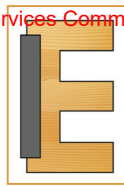

Post & Beam Shelters (WBS) (WBH) (WBO)



WBH30T-P4-WB

Squares, Hexagons and Octagons are simply and economically fabricated with architectural grade glue-laminated SYP rafters, purlins and tie beams. Columns can be architectural grade treated glue-laminated SYP, Alaskan Yellow Cedar or e-coated and powder coated steel tube.

Standard roof pitch for hexagons and octagons is 3/12. Standard roof pitch for gables and squares is 4/12. Cupolas, handrails and knee braces can be added at extra cost.



WBD24T-P4-WB

Squares	Hexagons	Octagons
WBS16	WBH16	WBO20
WBS20	WBH20	WBO24
WBS24	WBH24	WBO26
WBS30	WBH30	WBO30
WBS32	WBH32	WBO34
WBS35	WBH35	WBO36
WBS36	WBH36	WBO40
WBS40	WBH40	WBO45
WBS45	WBH45	WBO60
WBS50	WBH50	



WBS40T-P6-WB

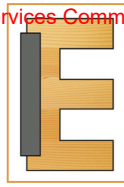

Bandshells and Amphitheater Structures



Half-Hex Band Shell with Solid Arches and Storage Rooms

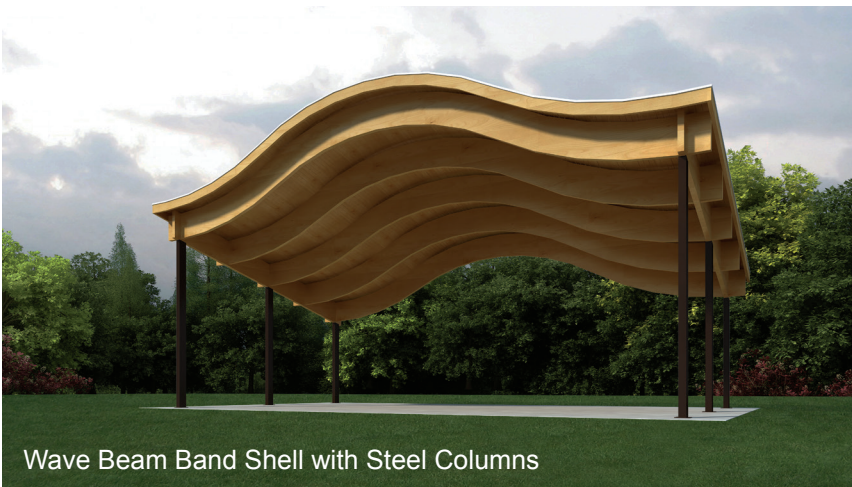

Wave Beam Band Shell with Steel Columns

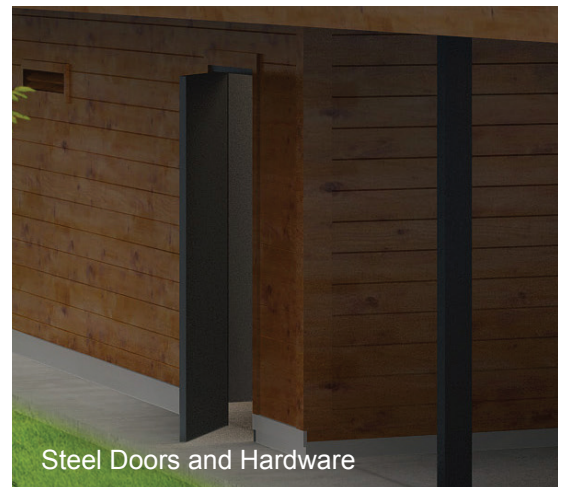

Steel Doors and Hardware

Two-piece laminated wood solid arches, and three-piece laminated wood open arches span from column-to-compression ring on the polygonal shelters, and column-to-ridge in rectangular shelters. These Gothic-style arches are used in half-hexagons, half-octagons and tapered rectangular bandshells. Also available are laminated wave beams for a unique appearance. EWS's exclusive wall system, utilizing decorative grade laminated red cedar timbers, can be added for back drops and side rooms to use for storage when not in use and for dressing rooms.

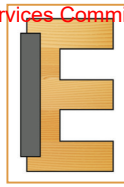

Restrooms, Concessions & Park Activity Buildings



ERG30X60TM-P3-WB-W with Solid Arches. Restroom and Storage

Adding walls to any EWS to enclose or partially enclose any structure can result in any number of building types. Restrooms, concession buildings, cabins, multi-use buildings, visitor centers and nature centers name some of the uses for Engineered Wood Structures with solid wood walls. Restroom plumbing and electrical fixtures are available for all packages, as well as restroom partitions, interior and exterior doors, windows, roll-up concession doors and garage doors.

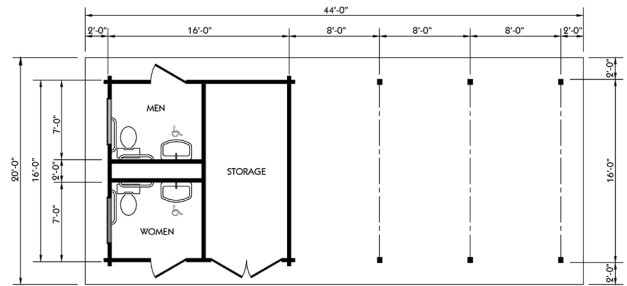

ERG20X44T-P3-W

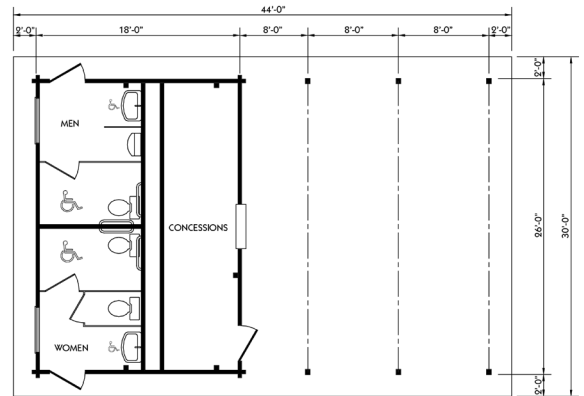

ERG30X44T-P3-W

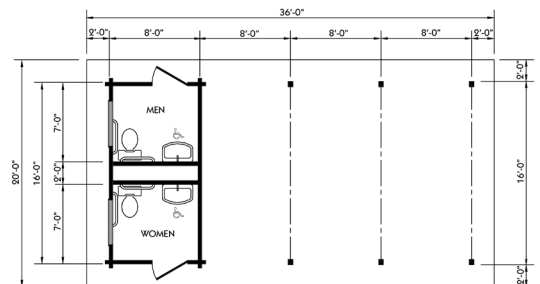

ERG20X36T-P3-W



ERG30X60TA-P3-SB-W with Steel Columns and Restrooms

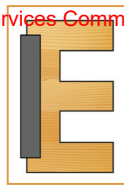

Gazebos

Gazebo designs are available in a variety of sizes. Each gazebo is constructed using glue-laminated Yellow Alaskan Cedar columns with architectural grade glu-laminated SYP rafters, tie beams and purlins. The roof decks are #1 SYP T&G with “V” groove on the ceiling side.

Options:

- Steel columns
- Cedar roof deck
- Handrails
- Finial peak cap
- Wood floor system with steps
- Benches



Pedestrian Bridges

One piece laminated wood beams or arches are the superstructure for wood pedestrian bridges.

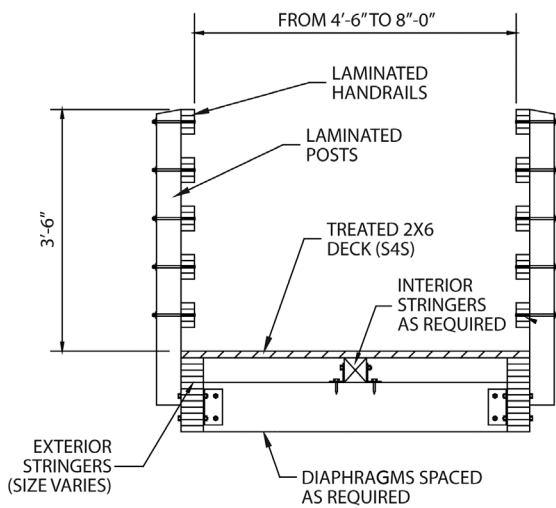

Clear deck widths are available from 4'-6" to 8'-0", and spans from 10'-0" to 80'-0". All laminated wood components are Southern Yellow Pine. Decking is treated 2x6 Southern Yellow Pine or recycled plastic planks. Connection plates are galvanized HRF and all fasteners are galvanized.

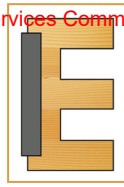

General Wood Specifications

Manufacture of structural glue-laminated timber wood components conform to manufacturing requirements of the American Institute of Timber Construction Standards, "Standard specification for structural glue-laminated timbers" AITC-117

Quality Control provided in accordance with ANSI/AITC A-190.1 latest edition. Quality standards shall be AITC, Structural Glue-Laminated Timber Construction Inspection Manual AITC-200.

Laminating Lumber combination meets requirements of the standard specification for structural glue-laminated timber AITC-117. Laminated lumber is #1 kiln-dried Southern Yellow Pine, graded to meet design values and requirements ASNI/AITC A-190.1.

Appearance Grades shall be architectural.

Columns glue-laminated Alaskan Yellow Cedar or treated Southern Yellow Pine in accordance with the American Wood Preservers Association Standards.

Roof Decking is 2" nominal #1 kiln-dried Southern Yellow Pine single tongue and groove with a "V" groove on the ceiling side.

Fascia is nominal 2x8 D and better S4S kiln-dried Western Red Cedar.

All structures are individually engineered to meet local code design loads.

ERECTION AND INSTALLATION OF ALL STRUCTURES shall be done with a competent supervisor in the construction trades according to EWS installation instructions providing good construction practices and procedures. The general contractor is responsible for the protection of material after arrival at destination. The contractor will be required to shim, cut and make adjustments of fitting for proper building erections.

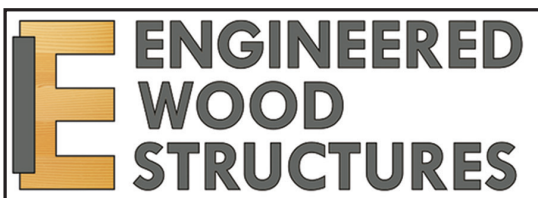

B E N
S H A F F E R
R E C R E A T I O N
973-663-2021 www.benshaffer.com